

50V, 500mA, Low-I_Q 40μA Low-Dropout Linear Regulator with Enable, Reset, Watchdog Functions

DESCRIPTION

The TQL850CSV50 is a high-performance low dropout linear regulator for 5V with input range of 3V to 50V and low quiescent 40μA. TQL850CSV50 provides 2% output voltage accuracy and 500mA maximum driving current and is suitable for automotive or other supply systems. TQL850CSV50 just requires one small ceramic capacitor of 1μF to exhibit fast regulation and good stability. And it shows very low dropout voltage with typical 60mV in 100mA-load and 150mV in 250mA-load. The start operating voltage is 3V which is suitable to cranking condition of automotive system.

The device has an enable function to switch ON and OFF for power dissipation. And other protection functions such as thermal-shutdown and current-limit are against immediate damage.

APPLICATION

- Automotive Power Supply Systems
- General Power Supply applications

FEATURES

- AEC-Q100 qualified with the following results:
 - Device temperature grade 1: -40°C to 125°C
 - Device HBM ESD classification level H2
 - Device CDM ESD classification level C3
- 3V to 50V Input Voltage Range
- 5V Fixed Output Voltage
- Typical 60mV @100mA Low Dropout Voltage
- 500mA Output Current
- Typical 40μA Low Quiescent Current
- Typical ±2% Output Voltage Accuracy
- 1μF Ceramic Output Stable Capacitor
- Output Current Limit
- Over Temperature Protection
- RoHS Compliant
- Halogen-Free according to IEC 61249-2-21

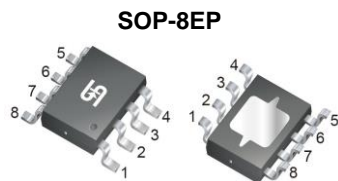

Pin Definition:

- | | |
|----------|--------|
| 1.IN | 5. RTH |
| 2.EN | 6. WDI |
| 3.RO/WDO | 7. NC |
| 4.GND | 8. OUT |

Notes: MSL 3 (Moisture Sensitivity Level) per J-STD-020

TYPICAL APPLICATION CIRCUIT

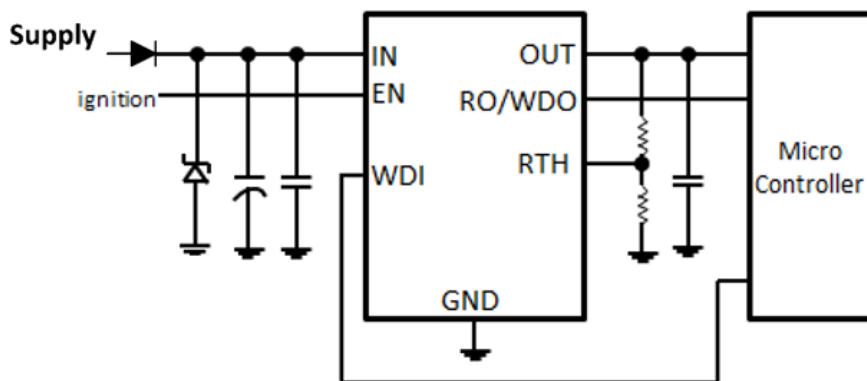

ABSOLUTE MAXIMUM RATINGS ($T_A = 25^\circ\text{C}$ unless otherwise specified) (Note 1)			
PARAMETER	SYMBOL	LIMIT	UNIT
Power Supply Pin	V_{IN}	55	V
EN Voltage to GND	V_{EN}	-0.3 to 55	V
OUT/RO/WDO Voltage to GND	V_{OUT}/V_{ROWDO}	-0.3 to 7	V
WDI/RTH Voltage to GND	V_{WDI}/V_{RTH}	-0.3 to 7	V
Junction Temperature Range	T_J	-40 to +150	$^\circ\text{C}$
Storage Temperature Range	T_{STG}	-55 to +150	$^\circ\text{C}$
ESD Rating (Human Body Model) (Note 2)	HBM	± 2	kV
ESD Rating (Charged Device Model)	CDM	± 1	kV

THERMAL PERFORMANCE			
PARAMETER	SYMBOL	TYP	UNIT
Junction to Case Thermal Resistance	$R_{\theta JC}$	11	$^\circ\text{C}/\text{W}$
Junction to Ambient Thermal Resistance	$R_{\theta JA}$	43	$^\circ\text{C}/\text{W}$

Notes: The thermal data is based on the PCB JESD 51-3 at natural convection on 1s0p board with 1 copper layer (1 x 70 μm Cu) and with 300mm² heatsink area on PCB

RECOMMENDED OPERATING CONDITIONS (Note 3)			
PARAMETER	SYMBOL	CONDITIONS	UNIT
Power Supply Pin	V_{IN}	$V_{OUT} + V_{dr}$ to 50	V
Extended Power Supply Pin	$V_{IN,ext}$	3 to 50	V
EN Voltage to GND	V_{EN}	0 to 50	V
Output Stable Capacitor	C_{OUT}	≥ 1	μF
ESR of Output Capacitor	ESR	≤ 100	Ω
Operating Junction Temperature Range	T_J	-40 to +150	$^\circ\text{C}$
Operating Ambient Temperature Range	T_{OPA}	-40 to +125	$^\circ\text{C}$

ELECTRICAL SPECIFICATIONS ($V_{IN} = 13.5\text{V}$, $T_J = -40$ to 150°C unless otherwise noted)						
PARAMETER	CONDITIONS	SYMBOL	MIN	TYP	MAX	UNIT
Supply Voltage						
Output Voltage	$0.05\text{mA} < I_{OUT} < 500\text{mA}$ $5.95\text{V} < V_{IN} < 28\text{V}$	V_{OUT}	4.9	5	5.1	V
Output Voltage	$0.05\text{mA} < I_{OUT} < 200\text{mA}$ $5.44\text{V} < V_{IN} < 40\text{V}$	V_{OUT}	4.9	5	5.1	V
Start-up Slew-rate	$V_{IN} > 18\text{V}/\text{ms}$ $C_{OUT} = 1\mu\text{F}$ $0.5\text{V} < V_{OUT} < 4.5\text{V}$	dV_{OUT}/dt	--	35	--	V/ms
Current Limit	$0\text{V} < V_{OUT} < 4.8\text{V}$	I_{lim}	501	650	1100	mA
Load Regulation	$I_{OUT} = 0.05$ to 500mA $V_{IN} = 6\text{V}$	$\Delta V_{OUT,lo}$	-20	-1.5	+15	mV

ELECTRICAL SPECIFICATIONS ($V_{IN} = 13.5V$, $T_J = -40$ to $150^{\circ}C$ unless otherwise noted)						
PARAMETER	CONDITIONS	SYMBOL	MIN	TYP	MAX	UNIT
Supply Voltage						
Line Regulation	$V_{IN} = 8$ to $32V$ $I_{OUT} = 5mA$	$\Delta V_{OUT,li}$	-20	0	20	mV
Dropout Voltage ($V_{dr}=V_{IN}-V_{OUT}$)	$I_{OUT} = 250mA$	V_{dr}	--	150	425	mV
Dropout Voltage ($V_{dr}=V_{IN}-V_{OUT}$)	$I_{OUT} = 100mA$	V_{dr}	--	60	170	mV
Power Supply Ripple Rejection	$f = 100Hz$ $V = 0.5V_{pp}$	PSRR	--	59	--	dB
Thermal Shutdown Threshold	Note 4	T_{th}	151	--	200	$^{\circ}C$
Thermal Shutdown Hysteresis	Note 4	T_{hy}	--	30	--	$^{\circ}C$
Current Consumption (PI1=PI2=WDI=GND)						
Standby Current ($I_o=I_{IN}$)	$V_{EN} = 0V$; $T_J \leq 105^{\circ}C$	$I_{o,st}$	--	1.3	5	μA
Standby Current ($I_o=I_{IN}$)	$V_{EN} = 0.4V$; $T_J \leq 125^{\circ}C$	$I_{o,st}$	--	--	8	μA
Quiescent Current ($I_o=I_{IN}-I_{OUT}$)	$I_{OUT} = 0.05mA$, $T_J=25^{\circ}C$	I_o	--	40	52	μA
Quiescent Current ($I_o=I_{IN}-I_{OUT}$)	$I_{OUT} = 0.05mA$, $T_J \leq 125^{\circ}C$	I_o	--	62	77	μA
Enable						
High Level Input Voltage		V_{ENH}	2	--	--	V
Low Level Input Voltage	$V_{OUT} \leq 0.1V$	V_{ENL}	--	--	0.8	V
Threshold Hysteresis		V_{ENHy}	100	--	--	mV
EN Input Current	$V_{EN} = 3.3V$	I_{EN}	--	--	3.5	μA
EN Input Current	$V_{EN} \leq 18V$	I_{EN}	--	--	22	μA
EN Pull-down Resistor		R_{EN}	0.95	1.5	2.6	$M\Omega$
Reset						
UVLO Reset Upper Threshold	V_{OUT} increasing	V_{RTH}	4.6	4.7	4.8	V
UVLO Reset Lower Threshold	V_{OUT} decreasing $R_{TH} = GND$	V_{RTL}	4.5	4.6	4.7	V
UVLO Reset Threshold Hysteresis	$R_{TH} = GND$	V_{RTHy}	60	100	--	mV
UVLO Reset Headroom ($V_{OUT}-V_{RTL}$)	$R_{TH} = GND$	V_{RH}	200	400	--	mV
UVLO Adjustment Threshold		V_{RTTH}	1.15	1.2	1.25	V
UVLO Adjustment Range		V_{RTRG}	2.5	--	4.4	V
Reset/Watchdog Output Low Voltage	$1V \leq V_{OUT} \leq V_{RTL}$ $R_{ROWDO} \geq 5.1k\Omega$	V_{ROWDOL}	--	0.2	0.4	V
Internal Pull-up Resistor	Connected to OUT	$R_{ROWDO,int}$	13	20	36	$k\Omega$
External Pull-up Resistor to OUT	$1V \leq V_{OUT} \leq V_{RTL}$ $V_{RO} \leq 0.4V$	$R_{ROWDO,ext}$	5.1	--	--	$k\Omega$
Reset Delay Time		t_{RD}	6.8	8.5	10.2	ms
Reset Blanking Time	Note 4	t_{RB}	--	7	--	μs

ELECTRICAL SPECIFICATIONS ($V_{IN} = 13.5V$, $T_J = -40$ to $150^{\circ}C$ unless otherwise noted)						
PARAMETER	CONDITIONS	SYMBOL	MIN	TYP	MAX	UNIT
Reset						
Internal Reset Reaction Time	Note 4	t_{RR}	--	10	33	μs
Watchdog						
Watchdog Ignore Time		$t_{WDI,i}$	12.8	16	19.2	ms
Watchdog Trigger Time		$t_{WDI,tr}$	38.4	48	57.6	ms
Watchdog Low Time		t_{WDOL}	6.4	8	9.6	ms
WDI High Signal Valid		V_{WDIH}	2.0	--	--	V
WDI Low Signal Valid		V_{WDIL}	--	--	0.8	V
WDI High Pulse Length (Note 4)	$V_{WDI} \geq V_{WDIH}$	$t_{WDI,ph}$	1	--	--	μs
WDI Low Pulse Length (Note 4)	$V_{WDI} \leq V_{WDIL}$	$t_{WDI,pl}$	1	--	--	μs
WDI Signal Slew Rate (Note 4)	$V_{WDIL} \leq V_{WDI} \leq V_{WDIH}$	dV_{WDI}/dt	1	--	--	V/ μs
WDI Input Current	$V_{WDI} = 3.3V$	I_{WDI}	--	--	3.5	μA
WDI Pull Down Resistor		R_{WDI}	0.9	1.5	2.6	$M\Omega$
WDI Disable Threshold	$V_{IN} > 5.95V$	$V_{WD,dis}$	1.15	--	1.4	V
Minimum Filter Time By WDI	Note 4	$t_{FWDI,min}$	100	--	--	μs
Maximum Filter Time By WDI	Note 4	$t_{FWDI,max}$	--	--	500	μs

Note:

1. Stresses listed as the above "Absolute Maximum Ratings" may cause permanent damage to the device. These are for stress ratings. Functional operation of the device at these or any other conditions beyond those indicated in the operational sections of the specifications is not implied. Exposure to absolute maximum rating conditions for extended periods may remain possibility to affect device reliability.
2. Devices are ESD sensitive. Handling precaution recommended.
3. The device is not guaranteed to function outside its operating conditions.
4. Guaranteed by design.

ORDERING INFORMATION

ORDERING CODE	PACKAGE	PACKING
TQL850CSV50 RLG	SOP-8EP	2,500pcs / 13" Reel

BLOCK DIAGRAM

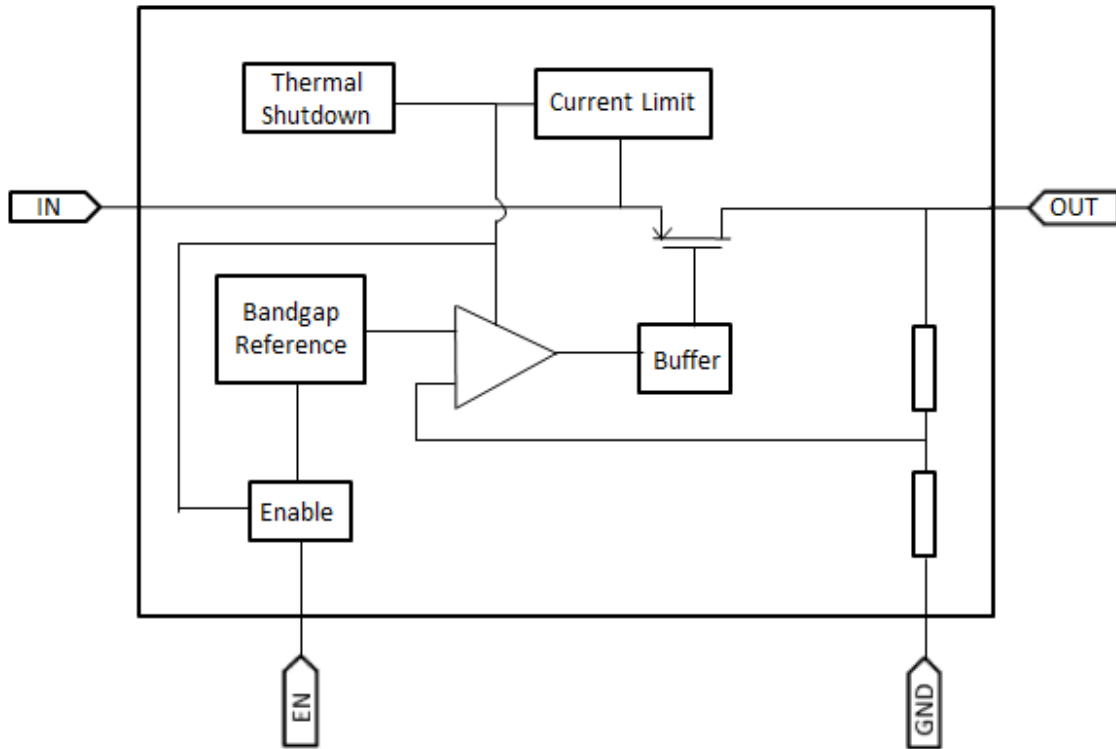

PIN DESCRIPTION

PIN NO.	NAME	FUNCTION
1	IN	Power supply pin for system
2	EN	Enable system function
3	RO/WDO	Reset and watchdog output
4	GND	Ground
5	RTH	Reset threshold adjustment
6	WDI	Watchdog monitor input
7	NC	No connect
8	OUT	Output supply voltage
Pad	--	Connect to GND

APPLICATION INFORMATION

TQL850CSV50 is a high-performance low dropout voltage regulator. The device operates with a wide input voltage from 3V to 50V and up to 500mA of output current. It also provides a high accuracy output voltage for $\pm 2\%$ in all the load and line regulation.

Reset

The TQL850CSV50 is monitored by Reset system including Power-ON Delayed Reset, Under-Voltage Reset, and Reset Threshold Adjustment. When reset is activated, the RO/WDO pin is low.

■ **Power-ON Delayed Reset**

When device starts up, the RO/WDO pin delays to become “High” in Power-ON Delayed Time (t_{RD}) without reset issue.

■ **Under-Voltage Reset**

When the output supply voltage drops below UVLO Reset Lower Threshold (V_{RTL}), the RO/WDO switches from “High” to “Low”. The RO/WDO pin is an open collector output with an internal pull-up resistor.

■ **Reset Threshold Adjustment**

The UVLO Reset Lower Threshold can be adjusted. If the RTH pin connects to GND, the threshold voltage is default value (V_{RTL}). We can take two resistors (R_{th1} , R_{th2}) to adjust under-voltage threshold. The R_{th1} is connected between OUT pin and RTH pin and R_{th2} is connected between RTH and GND. The reminder is taking proper resistance for current sourcing. The new threshold voltage is calculated as follows:

$$V_{RTL,new} = V_{RTTH} \times (R_{th1} + R_{th2}) / R_{th2}$$

- $V_{RTL,new}$: Desired switching threshold
- R_{th1} , R_{th2} : External divider resistors
- V_{RTTH} : Reset adjust switching threshold

Watchdog

The TQL850CSV50 has the watchdog function with fixed watchdog timing to monitor microcontroller process. The device monitors the period clock-pulse provided by Microcontroller at WDI pin in a certain timing (Watchdog Trigger Time, $t_{WDI,tr}$). If there is no signal in Watchdog Trigger Time, the RO/WDO pin becomes “Low” in a certain time (Watchdog Low Time, t_{WDOL}). After that, the RO/WDO pin returns to “High” and keep watching the WDI signal repeatedly. The RO/WDO pin is an open collector output with an internal pull-up resistor.

The Watchdog function is inactivated by WDI pin. While the WDI voltage is in 1.15V to 1.4V, the Watchdog function is disable.

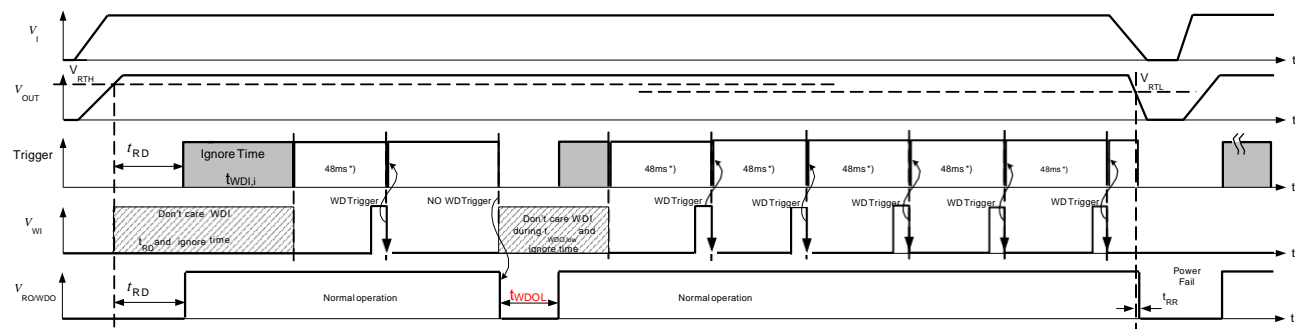

Typical Watchdog Timing Diagram, Watchdog and Reset Modes

APPLICATION INFORMATION (CONTINUE)

Enable

The EN pin is high voltage tolerant pin. High input enables the device ON and low is disable which can be connected to microcontroller or digital control system. It can be connected to input power pin directly.

Thermal Shutdown (TSD)

Internal 160°C comparator will trigger temperature protection (TSD). TSD will shut down system, until internal temperature back to 130°C.

Current Limit

The TQL850CSV50 features Current Limit function to protect device from damage by excessive power dissipation such as OUT shorted to GND. It limits output current to maintain power dissipation in the safe region.

Typical Timing Diagram Reset

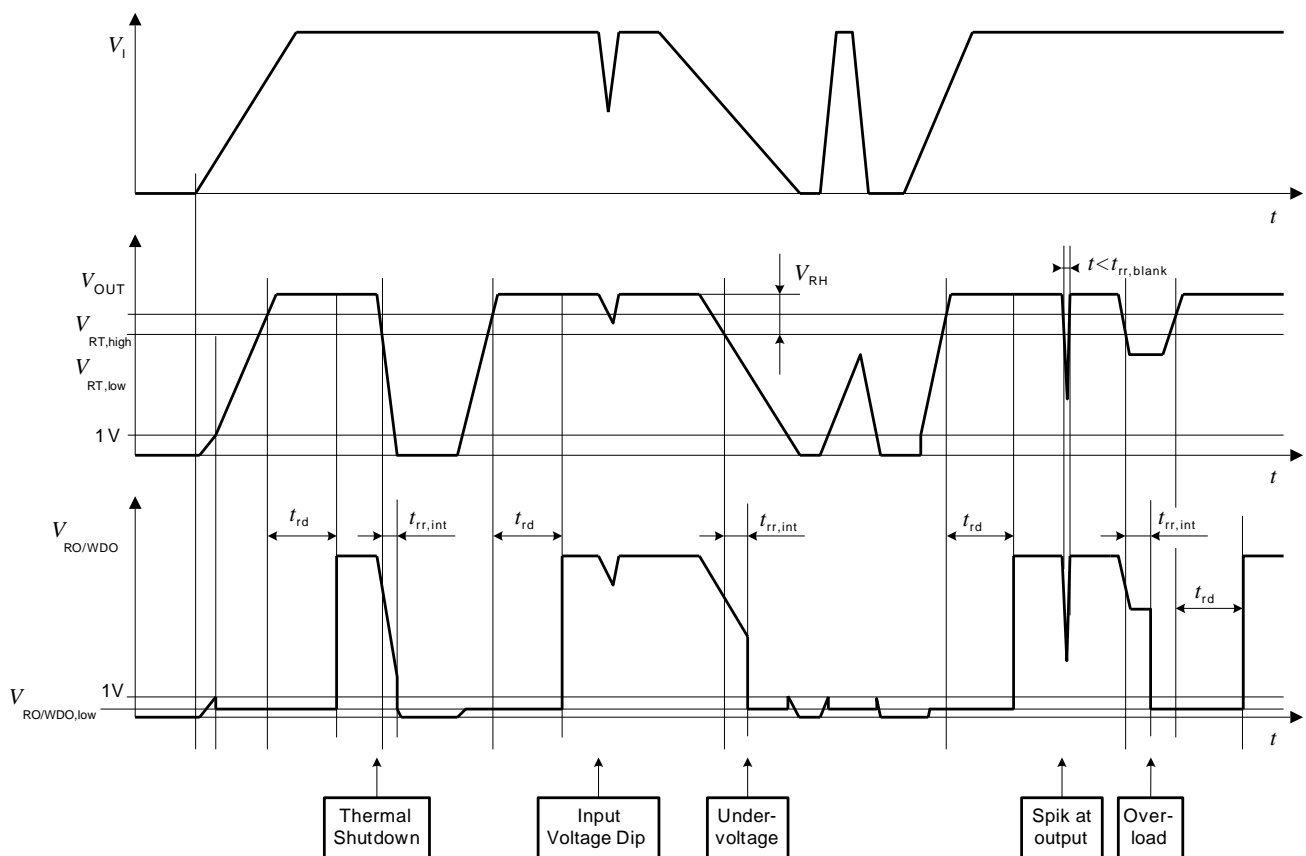

TYPICAL OPERATING CHARACTERISTICS

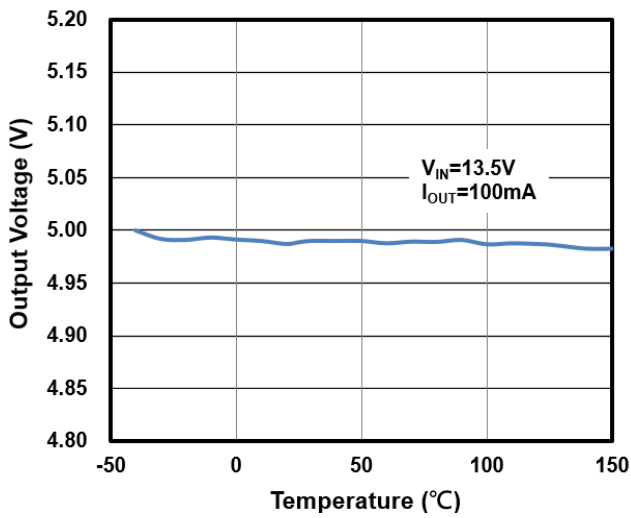

Figure 1. Output Voltage vs. Junction Temperature

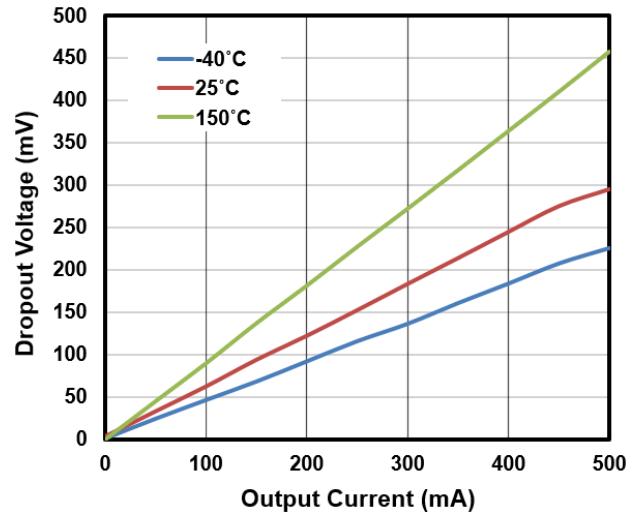

Figure 2. Dropout Voltage vs. Output Current

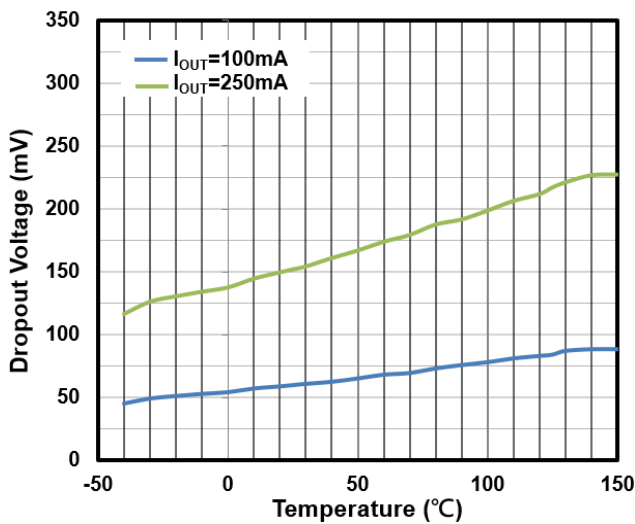

Figure 3. Dropout Voltage vs. Junction Temperature

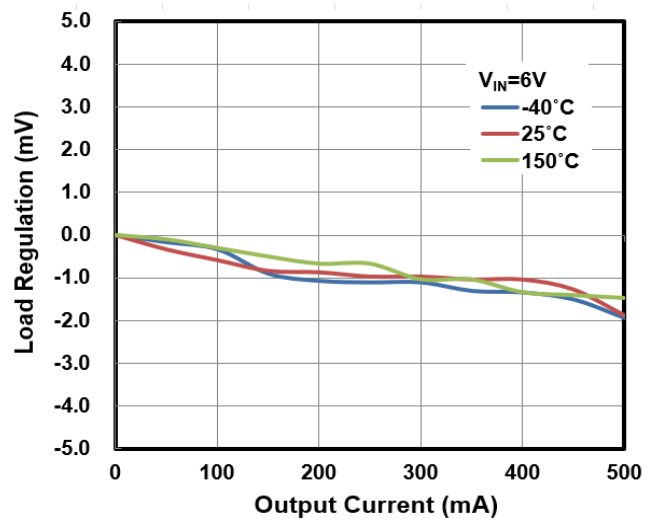

Figure 4. Load Regulation vs. Output Current

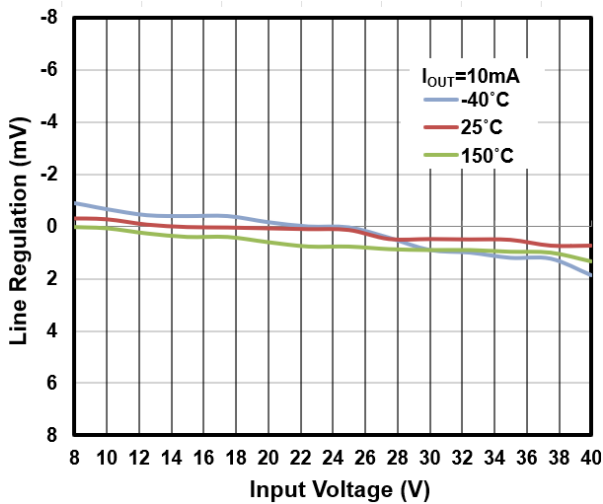

Figure 5. Line Regulation vs. Input Voltage

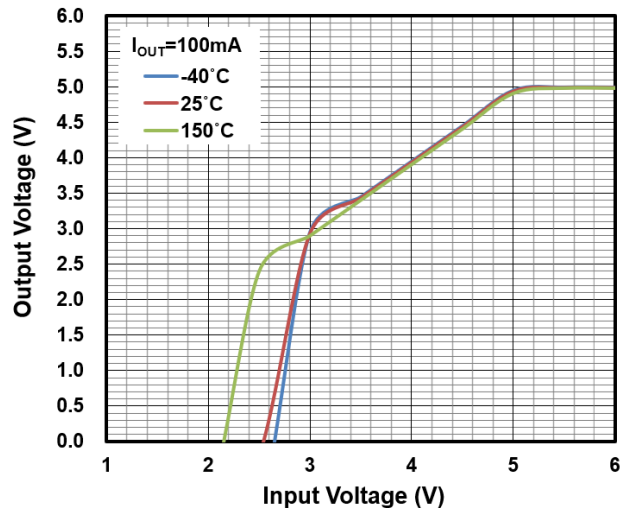

Figure 6. Output Voltage vs. Input Voltage

TYPICAL OPERATING CHARACTERISTICS (CONTINUE)

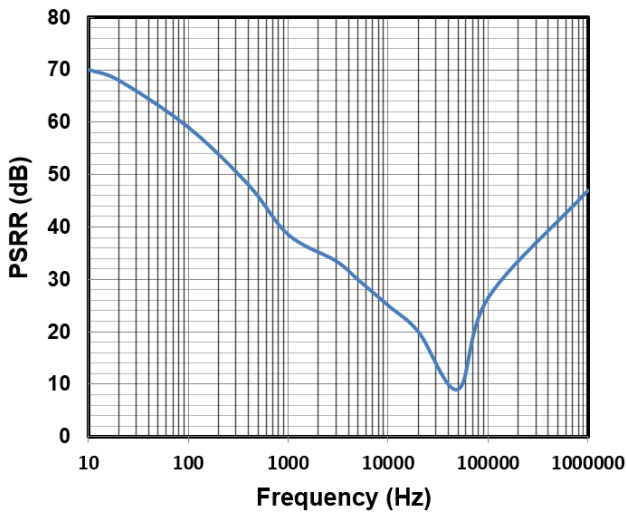

Figure 7. Ripple Rejection vs. Frequency

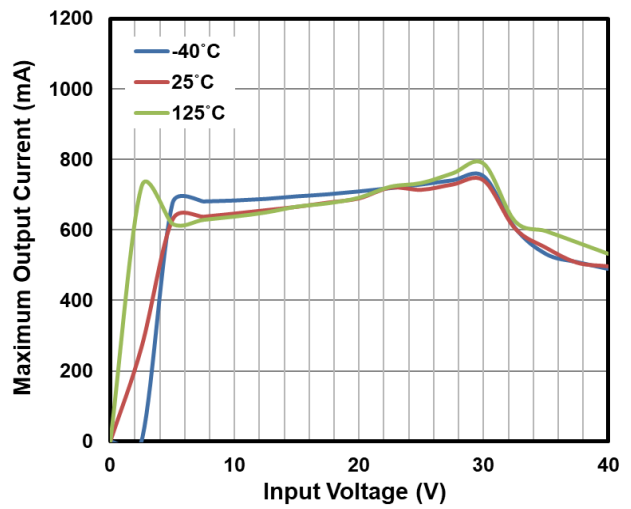

Figure 8. Output Current vs. Input Voltage

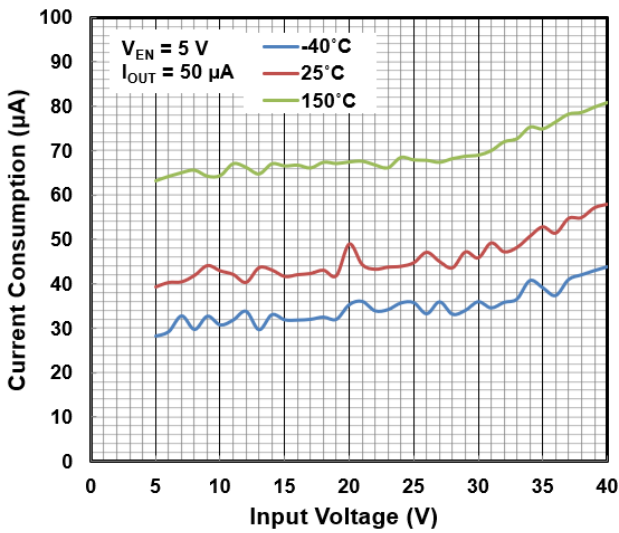

Figure 9. Current Consumption vs. Input Voltage

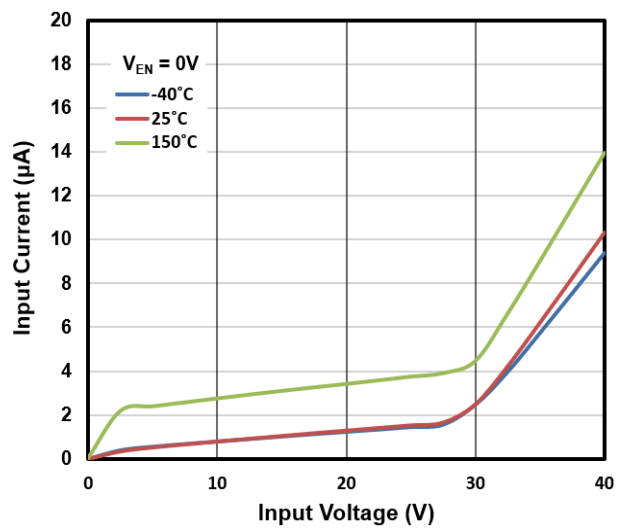

Figure 10. Input Current vs. Input Voltage

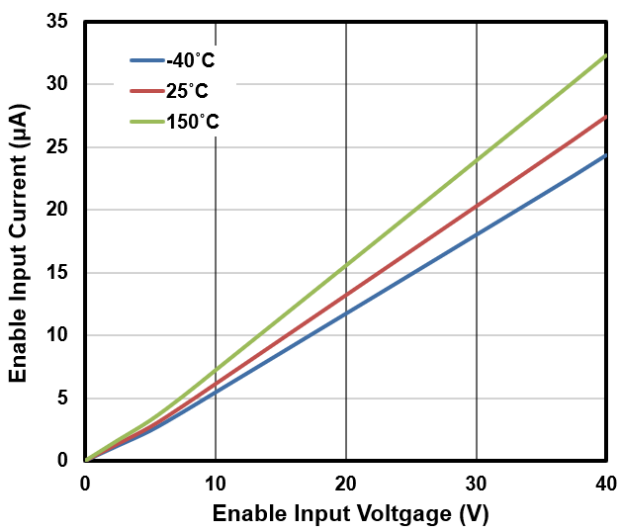

Figure 11. Enabled Input Current vs. Enabled Input Voltage

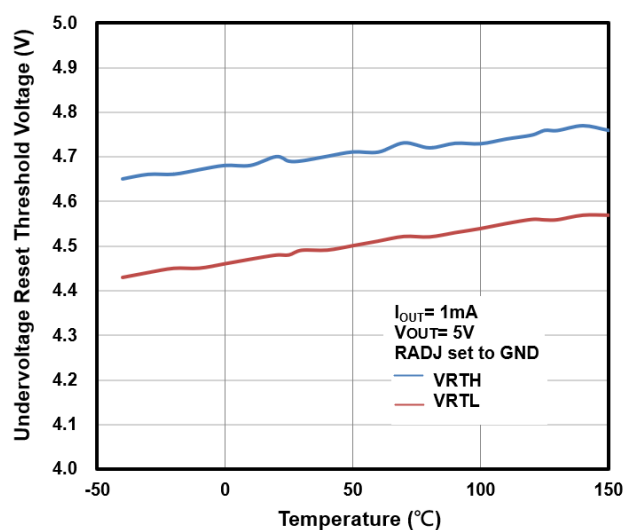

Figure 12. Undervoltage Reset Threshold vs. Junction Temperature

TYPICAL OPERATING CHARACTERISTICS (CONTINUE)

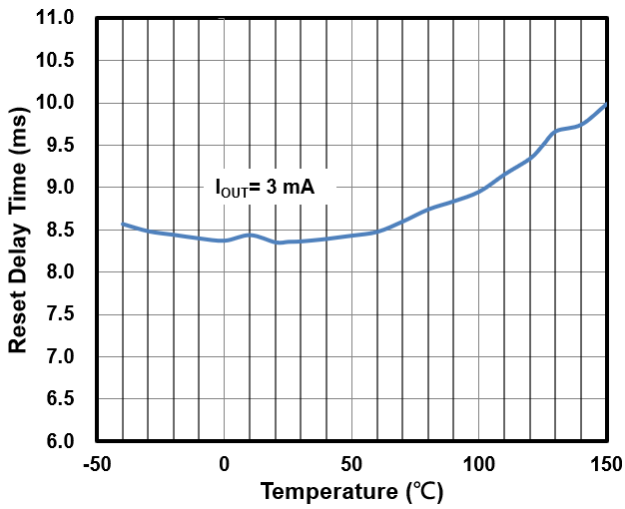

Figure 13. Power On Reset Delay Time vs. Junction Temperature

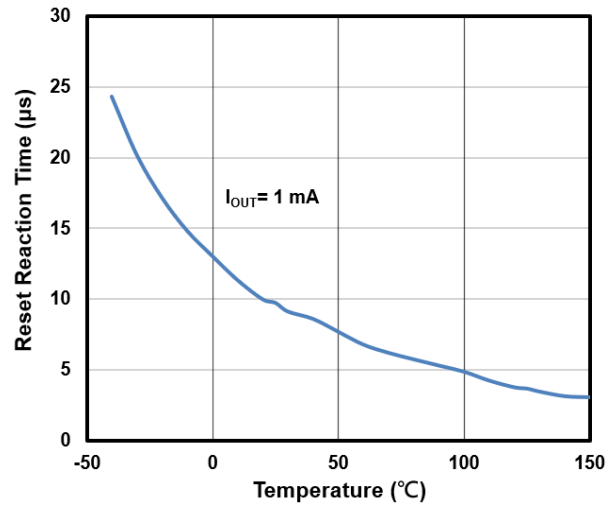

Figure 14. Internal Reset Reaction Time vs. Junction Temperature

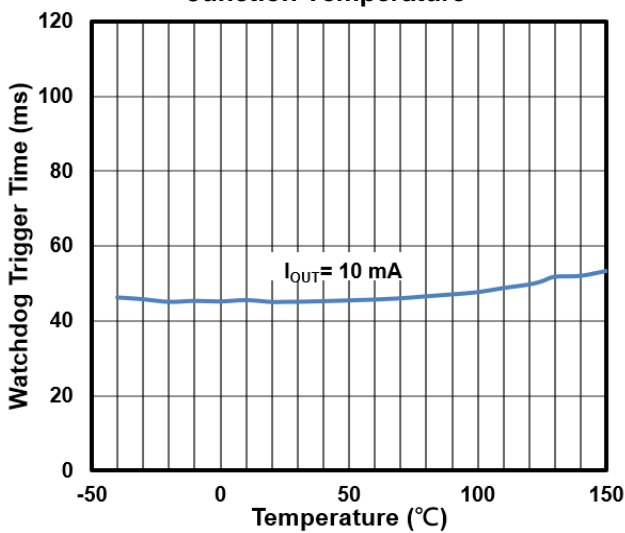

Figure 15. Watchdog Trigger Time vs. Junction Temperature

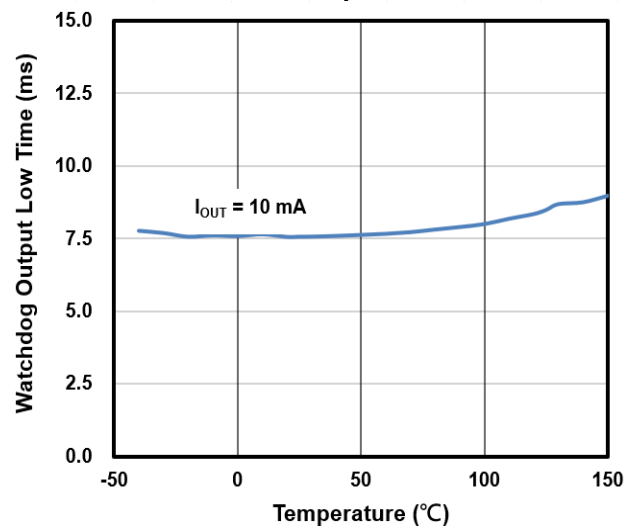

Figure 16. Watchdog Output Low Time vs. Junction Temperature

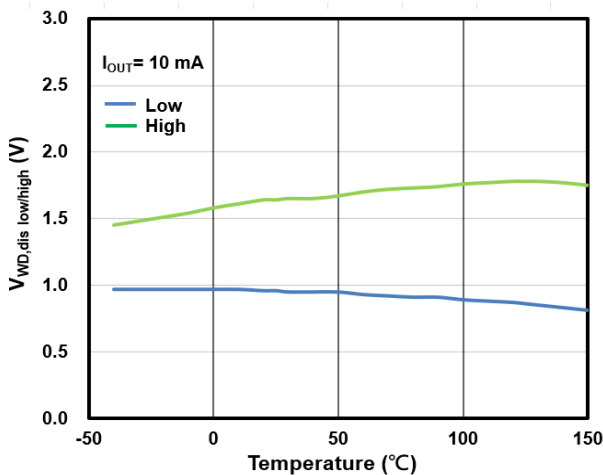

Figure 15. Watchdog Disable Threshold vs. Junction Temperature

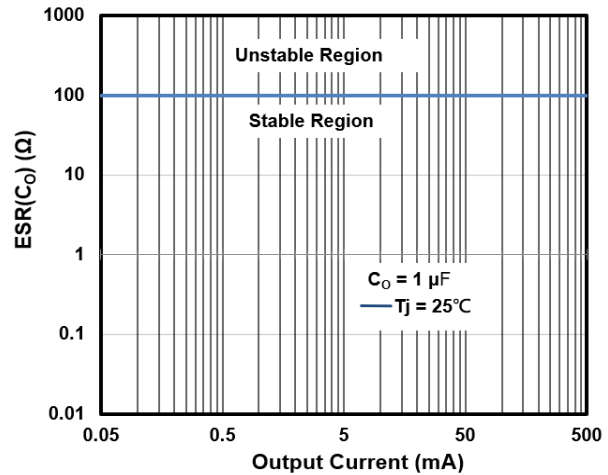

Figure 16. Output Capacitor Series Resistor ESR(C_O) vs. Output Current

TYPICAL OPERATING CHARACTERISTICS (CONTINUE)

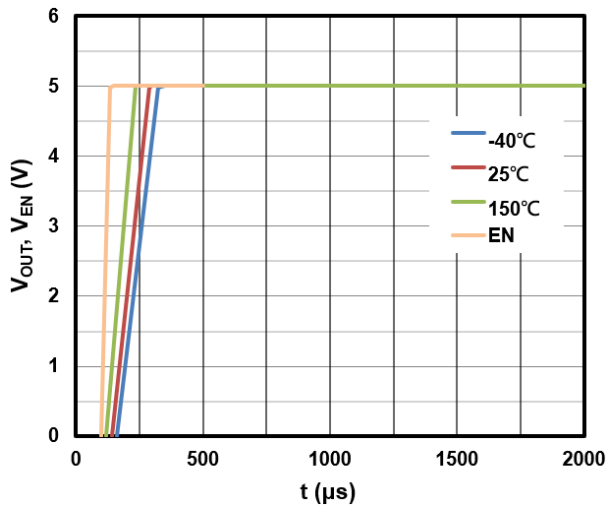
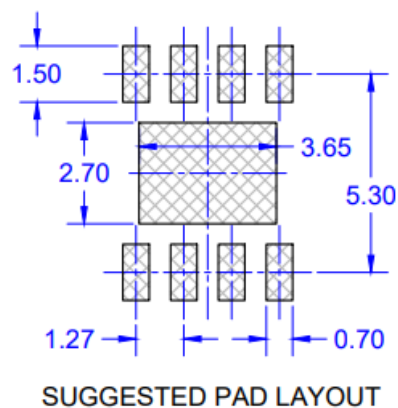
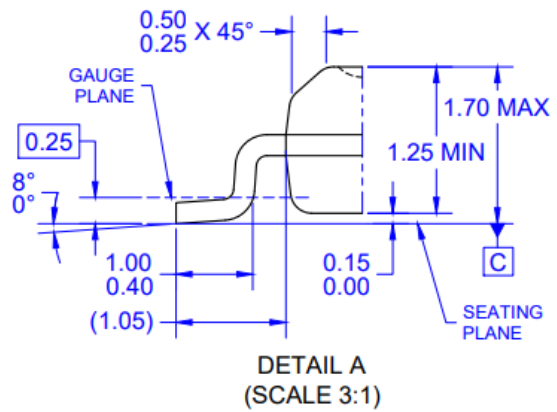
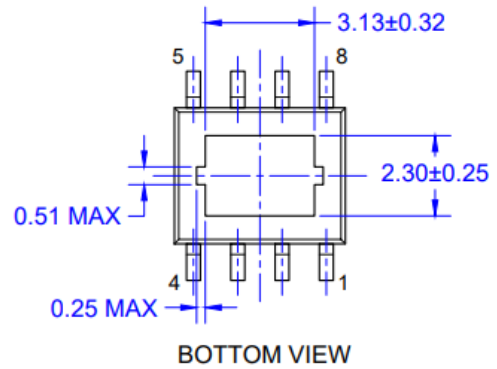
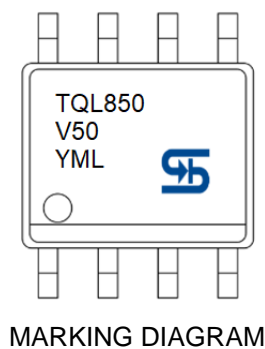
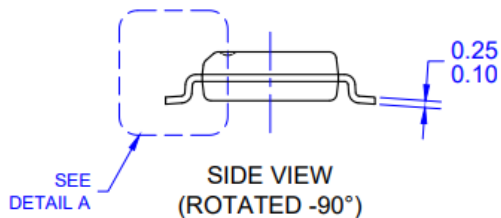
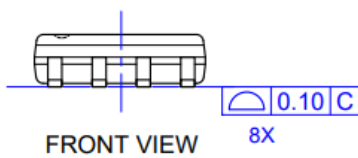
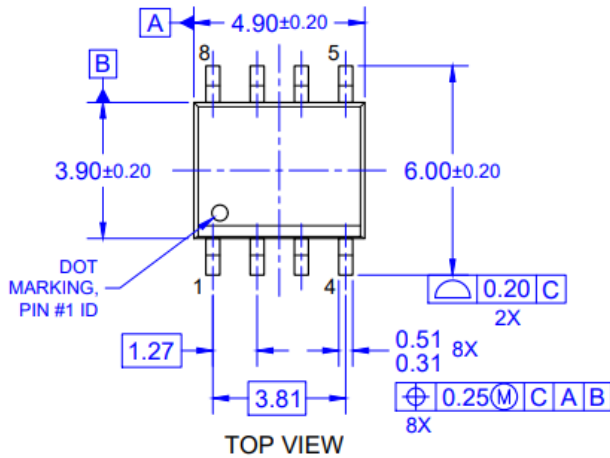

Figure 17. Output Voltage vs. time (EN switched ON)

PACKAGE OUTLINE DIMENSIONS

SOP-8EP



- Y** = Year Code
- M** = Month Code for Halogen Free Product
 - O** =Jan **P** =Feb **Q** =Mar **R** =Apr
 - S** =May **T** =Jun **U** =Jul **V** =Aug
 - W** =Sep **X** =Oct **Y** =Nov **Z** =Dec
- L** = Lot Code (1~9, A~Z)

NOTES: UNLESS OTHERWISE SPECIFIED

1. ALL DIMENSIONS ARE IN MILLIMETERS.
2. DIMENSIONING AND TOLERANCING PER ASME Y14.5M-1994.
3. PACKAGE OUTLINE REFERENCE: JEDEC MS-012, ISSUE G, VARIATION BA.
4. MOLDED PLASTIC BODY DIMENSIONS DO NOT INCLUDE MOLD FLASH, PROTRUSIONS OR GATE BURRS.
5. DWG NO REF: HQ2SD07-030 REV A.